



## Cold Rolled Stainless Steel Sheet and Strip

### ■ Head Office

2-6-1 Otemachi, Chiyoda-ku, Tokyo 100-0004, Japan  
Phone +81-3-3276-4800

### ■ Sales Offices

#### Osaka Sales Office

Yodoyabashi-Mitsui Bldg. 3F, 4-1-1 Imabashi,  
Chuo-ku, Osaka-shi, Osaka 541-0042, Japan  
Phone +81-6-4706-1180

#### Kyushu Sales Office

Hakata-NS Bldg. 4F, 5-18 Tenya-machi,  
Hakata-ku, Fukuoka-shi,  
Fukuoka 812-8522, Japan  
Phone +81-92-273-7090

#### Niigata Sales Office

COI-Niigata Bldg. 8F, 1-4-2 Higashi Oodori,  
Chuo-ku, Niigata-shi, Niigata 950-0087, Japan  
Phone +81-25-246-3113

#### Nagoya Sales Office

NS Bldg. 5F, 2-13-18 Meieki-minami, Nakamura-ku,  
Nagoya-shi, Aichi 450-0003, Japan  
Phone +81-52-581-2012

#### Chugoku Sales Office

Hiroshima-Teppou-chou Bldg. 14F,  
10-12 Teppou-chou, Naka-ku  
Hiroshima-shi, Hiroshima 730-0017, Japan  
Phone +81-82-511-5115

### ■ Overseas Offices

#### NSSC Bangkok Office

NS-Thainox Auto Company Limited,  
20th Floor, Thosapol Land III,  
947 Moo 12 Bangna-Trad Km. 3 Road,  
Bangna, Bangkok, Thailand  
Phone +66-2-744-0720

#### NSSC Guangzhou Office

Rm No.1206-1208 Garden Tower,  
368 Huanshi Dong Lu,  
Guangzhou 510064, China  
Phone +86-20-83652458

### ■ Works

#### Hikari Works

3434 Ooaza-shimada,  
Hikari-shi, Yamaguchi  
743-8550, Japan  
Phone +81-833-71-5004

#### Kashima Works

2-1 Hikari, Kashima-shi,  
Ibaraki 314-0014, Japan  
Phone +81-299-84-3702

#### Yawata Works

2108-1 Aza-hato, Ooaza-maeda,  
Yawatahigashi-ku, Kitakyushu-shi,  
Fukuoka 805-0058, Japan  
Phone +81-93-672-2356

For further information, please contact to the following department or nearest office

**Products Development Division**  
**Nippon Steel & Sumikin Stainless Steel Corporation Head Office**  
Phone : +81-3-3276-4890  
Facsimile : +81-3-3276-5292

**Nippon Steel & Sumikin Stainless Steel Corporation**



# Cold Rolled Stainless Steel Sheet and Strip

**Nippon Steel & Sumikin Stainless Steel Corporation**





The stainless steel divisions of Nippon Steel Corporation and Sumitomo Metal Industries, Ltd. were consolidated into a new company named Nippon Steel & Sumikin Stainless Steel Corporation in 2003.

The most sophisticated stainless steel manufacturing technologies as well as state-of-the-art quality control systems, developed and held by each of these two companies, have now been integrated and wholly taken over by this new company. Moreover, as Nippon Steel & Sumikin Stainless Steel Corporation plans to strengthen R&D focusing on stainless steel, the company is confident that it will be able to meet the strictest requirements demanded by customers with its stainless steel sheet and strip.

## Cold Rolled Stainless Steel Sheet and Strip

### Contents

- 1 ■ Features
- 2 ■ Application Examples
- 4 ■ Production Grades  
–with information on Characteristics and Applications –
- 8 ■ Guide to Selection of Appropriate Grade of NSSC Series Stainless Steels
- 10 ■ Sizes Available
- 14 ■ Manufacturing Process
- 16 ■ Surface Finishes
- 17 ■ Table of Mass
- 18 ■ Marking and Packing
- 19 ■ Product Handling Instructions
  - Information required with Orders
- 20 ■ Material Safety Data Sheet

#### Important notice

The technical information in this document simply describes typical characteristics and performance of the product and does not provide any guarantees except for the items clearly stated as specifications or standard values.  
 Note that NSSC takes no responsibility whatsoever for damage resulting from user failure to observe the instructions presented in this document or improper handling of the product.  
 The information presented in this document is subject to change without notice. Please contact the relevant division for the latest information.  
 No part of this document may be copied or reproduced in any form without the consent of NSSC.

## Cold Rolled Stainless Steel Sheet and Strip

### Features

Exquisite quality characteristics and appearance will lead you fresh satisfaction. ◆

#### 1 Quality in uniformly highest level

Rigorous quality control is practiced throughout production from steel-making and cold rolling to finishing.

#### 2 State-of-the-art technology for flatness and thickness accuracy

The most advanced cold-rolling mills produce strip having highly accurate flatness and thickness.

#### 3 Wide range of grades and sizes

A wide range of steel grades and product sizes ranging from 0.2 mm to 6.0 mm in thickness and up to 1,524 mm in width and 8,000 mm in length are available to meet various applications. You can choose the stainless steel sheet or strip that is most suitable for your application purpose.

Standard widths available are 914 mm (3 feet), 1,000 mm, 1,219 mm(4 feet) and 1,524 mm (5 feet).

#### 4 Attractively fine surface finishes

Meticulous care is taken in grinding the surfaces of cold-rolling mill rolls and in carrying out annealing and pickling operations of the products so as to provide attractive surface finishes inherent to stainless steel. Products requiring finishes ranging from No. 3 to Buffing polished and hair-line finishes can also be produced to order.



# Application Examples

Nippon Steel & Sumikin Stainless Steel's stainless steel sheet and strip are highly suited for a wide range of applications from kitchen utensils to roof of dome.



Pans for IH cooker



IH rice cooker



Railway car



Escalator



Refrigerator and freezer



Kitchen fixture



Stadium (Osaka Dome)



Exhibition hall (Nagoya International Exhibition Hall)



# Production Grades

-with information on Characteristics and Applications-  
(Austenitic type and Duplex type)

Nippon Steel & Sumikin Stainless Steel produces all grades of stainless steel sheet and strip in accordance with JIS 4305 (Cold Rolled Stainless Plates and Sheets) as well as other JIS specifications than #4305 upon customer's request.

Moreover, it can provide with higher grades of stainless steel sheet and strip titled 'NSSC' series which have been developed on the basis of common grades such as JIS in order to meet customers' needs for specific application.

**Austenitic type :** The austenitic type stainless steels, as far as worked with solid solution heat treatment, are non-magnetic and nonhardenable by heat treatment, while they exhibit a wide range of mechanical properties and become slightly magnetic when cold worked. And especially, they can exhibit the maximum softness, elongation and corrosion resistance in its annealed state; that is, rapid cooling from high temperatures.

**Duplex (austenitic-ferritic) type :** With a duplex structure of austenite and ferrite, duplex type stainless steels show excellence in corrosion resistance and strength.

Specification group	Characteristics		Symbol of grade (ex-YUS/NAR Series)	Typical composition	Corresponding grade	Applications	Chemical composition by selected element (weight %)										Mechanical properties					Physical properties					
	primary	quasi-primary					C	Si	Mn	P	S	Ni	Cr	Mo	N	Other significant elements	Yield strength 0.2% offset N/mm <sup>2</sup>	Tensile strength N/mm <sup>2</sup>	Elongation %	Hardness Hv	Inside radius of 180° bend test specimen	Density kg/mm <sup>3</sup>	Electric resistivity 10 <sup>-8</sup> Ωm(ρt)	Specific heat kJ/kg/°C	Thermal conductivity W/m/°C	Coefficient of thermal expansion × 10 <sup>-6</sup> /°C	Young's modulus kN/mm <sup>2</sup>
JIS products	Strain hardening	Intergranular corrosion resistance, Weldability	SUS 301	17Cr-7Ni	ASTM 301	Springs	≤0.15	≤1.00	≤2.00	≤0.045	≤0.030	6.00-8.00	16.00-18.00	-	-	-	≥205	≥520	≥40	≤218	-	7.93	72	0.50	16.3	16.9	193
			SUS 301L	17Cr-7Ni-N-LC	-	Rainway car, Press plate	≤0.030	≤1.00	≤2.00	≤0.045	≤0.030	6.00-8.00	16.00-18.00	-	≤0.20	-	≥215	≥550	≥45	≤218	-	7.93	72	0.50	16.3	16.9	193
	Austenitic type for general use	Formability	SUS 304	18Cr-8Ni	ASTM 304	Home appliance, Chemical plant, Decorative structural member, Rainway car	≤0.08	≤1.00	≤2.00	≤0.045	≤0.030	8.00-10.50	18.00-20.00	-	-	-	≥205	≥520	≥40	≤200	-	7.93	72	0.50	16.3	17.3	193
			SUS 304Cu	18Cr-8Ni-Cu	-	Home appliance, Chemical plant, Decorative structural member, Rainway car	≤0.08	≤1.00	≤2.00	≤0.045	≤0.030	8.00-10.50	18.00-20.00	-	-	Cu:0.70-1.30	≥205	≥520	≥40	≤200	-	7.93					
	Intergranular corrosion resistance		SUS 304L	18Cr-9Ni-LC	ASTM 304L	Oil refinery, Chemical plant, Nuclear power plant, Paper-making plant	≤0.030	≤1.00	≤2.00	≤0.045	≤0.030	9.00-13.00	18.00-20.00	-	-	-	≥175	≥480	≥40	≤200	-	7.93	72	0.50	16.3	17.3	193
	High strength		SUS 304N2	18Cr-8Ni-N-Nb	ASTM XM21	High-strength structural member, High-pressure gas cylinder	≤0.08	≤1.00	≤2.50	≤0.045	≤0.030	7.50-10.50	18.00-20.00	-	0.15-0.30	Nb≤0.15	≥345	≥690	≥35	≤260	-	7.93	72	0.50	16.3	17.3	193
	Formability		SUS 305	18Cr-12Ni-0.1C	ASTM 305	Cold-drawn product, Expansion briquetting machine, Spun parts	≤0.12	≤1.00	≤2.00	≤0.045	≤0.030	10.50-13.00	17.00-19.00	-	-	-	≥175	≥480	≥40	≤200	-	7.93	72	0.50	16.3	17.3	193
	Corrosion resistance	Heat resistance	SUS 309S	22Cr-12Ni	ASTM 309S	Boiler, Combustion chamber, Exhaust system, Gas turbine	≤0.08	≤1.00	≤2.00	≤0.045	≤0.030	12.00-15.00	22.00-24.00	-	-	-	≥205	≥520	≥40	≤200	-	7.98	78	0.50	13.8	14.9	193
	Oxidation resistance	Heat resistance	SUS 310S	25Cr-20Ni	ASTM 310S	Boiler, Combustion chamber, Exhaust system, Gas turbine	≤0.08	≤1.50	≤2.00	≤0.045	≤0.030	19.00-22.00	24.00-26.00	-	-	-	≥205	≥520	≥40	≤200	-	7.98	78	0.50	16.3	14.4	200
	Corrosion resistance	Stress corrosion cracking resistance	SUS 316	18Cr-12Ni-2.5Mo	ASTM 316	Oil refinery, Chemical plant, Nuclear power plant, Paper-making plant	≤0.08	≤1.00	≤2.00	≤0.045	≤0.030	10.00-14.00	16.00-18.00	2.00-3.00	-	-	≥205	≥520	≥40	≤200	-	7.98	74	0.50	16.3	16.0	193
		Intergranular corrosion resistance	SUS 316L	18Cr-12Ni-2.5Mo-LC	ASTM 316L	Oil refinery, Chemical plant, Nuclear power plant, Paper-making plant	≤0.030	≤1.00	≤2.00	≤0.045	≤0.030	12.00-15.00	16.00-18.00	2.00-3.00	-	-	≥175	≥480	≥40	≤200	-	7.98	74	0.50	16.3	16.0	193
		Pitting corrosion resistance	SUS 317	18Cr-12Ni-3.5Mo	ASTM 317	Oil refinery, Nuclear power plant, Paper-making plant, Textile dyeing plant	≤0.08	≤1.00	≤2.00	≤0.045	≤0.030	11.00-15.00	18.00-20.00	3.00-4.00	-	-	≥205	≥520	≥40	≤200	-	7.98	74	0.50	16.3	16.0	193
		Pitting corrosion resistance, Intergranular corrosion resistance	SUS 317L	18Cr-12Ni-3.5Mo-LC	ASTM 317L	Chemical plant, Textile plant	≤0.030	≤1.00	≤2.00	≤0.045	≤0.030	11.00-15.00	18.00-20.00	3.00-4.00	-	-	≥175	≥480	≥40	≤200	-	7.98	74	0.50	16.3	16.0	193
Intergranular corrosion resistance		SUS 321	18Cr-9Ni-Ti	ASTM 321	Jet-engine, Pressure furnace, Chemical plant	≤0.08	≤1.00	≤2.00	≤0.045	≤0.030	9.00-13.00	17.00-19.00	-	-	Ti≥5×C	≥205	≥520	≥40	≤200	-	7.93	72	0.50	16.3	16.7	193	
Intergranular corrosion resistance		SUS 347	18Cr-9Ni-Nb	ASTM 347	Chemical plant, Energy-related plat	≤0.08	≤1.00	≤2.00	≤0.045	≤0.030	9.00-13.00	17.00-19.00	-	-	Nb≥10×C	≥205	≥520	≥40	≤200	-	7.98	73	0.50	16.3	16.7	193	
Formability		SUS XM7	18Cr-9Ni-3.5Cu	-	Vessel, Container, deep-drawing product	≤0.08	≤1.00	≤2.00	≤0.045	≤0.030	8.50-10.50	17.00-19.00	-	-	Cu:3.00-4.00	≥155	≥450	≥40	≤200	-	7.93		0.50	16.7	17.3	193	
NSSC products	High elongation		NSSC 27A (YUS 27A)	17Cr-7Ni-2Cu	-	Kitchen sink, Hot-water tank, Door knob	≤0.08	≤2.00	≤2.00	≤0.040	≤0.030	6.00-8.00	16.00-18.00	-	-	Cu:1.50-2.50	≥205	≥520	≥40	≤200	-	7.93	71		15.9	17.3 (RT-100°C)	
	Formability	Stress corrosion cracking resistance	NSSC 27AM (YUS 27A-M)	17Cr-7Ni-2Cu-1.5Si	SUS 304J1	Hot-water tank, Dish washer	≤0.08	1.00-2.00	≤2.00	≤0.040	≤0.030	6.00-8.00	16.00-18.00	-	-	Cu:1.50-2.50	≥205	≥520	≥40	≤200	-	7.93	71		15.9	17.3 (RT-100°C)	
		Soft	NSSC 27AS	17Cr-7Ni-2Cu-LC,N	-	Design oriented kitchen sink	≤0.05	≤2.00	≤2.00	≤0.040	≤0.030	6.00-8.00	15.00-18.00	-	≤0.03	Cu:1.50-2.50	≥155	≥450	≥40	≤200	-	7.93					
		Season cracking resistance	NSSC 304RM2 (NAR-304RM2)	18Cr-9Ni-1Cu	-	Kitchen sink, Beer barrel, Coin	≤0.08	≤1.00	≤2.00	≤0.045	≤0.030	9.00-10.00	18.00-20.00	-	-	Cu:0.5-1.5	≥205	≥540	≥50	≤188	-	7.93					
	Soft, Season cracking resistance	NSSC 304JS	17Cr-8Ni-3Mn-3Cu-LC,N	SUS 304J1 SUS 304J2	Precision press equipment	≤0.03	≤1.00	1.50-3.50	≤0.040	≤0.030	7.00-9.00	16.00-18.00	-	≤0.03	Cu:2.00-4.00	≥155	≥450	≥40	≤200	-	7.91	76	0.50	16.4	16.7 (RT-100°C)	198	
	High strength		NSSC 304N (YUS 304N)	18Cr-8Ni-0.2N-Nb	SUS 304N2 ASTM XM-21	High-strength application, High-pressure equipment	≤0.08	≤1.00	≤2.50	≤0.040	≤0.030	7.50-10.50	18.00-20.00	-	≤0.25	Nb≤0.14	≥345	≥690	≥40	≤260	-	7.93	72	0.50	16.3	17.3 (RT-100°C) 20.9 (RT-1000°C)	193
	Corrosion resistance	Stress corrosion cracking resistance	NSSC 110M (YUS 110M)	18Cr-10Ni-2Cu-2Si-0.8Mo	SUS 315J1	Home appliance, Hot-water-supply system, Heat exchanger	≤0.08	1.50-2.50	≤1.00	≤0.030	≤0.030	9.50-11.50	17.50-19.50	0.50-1.00	-	Cu:1.50-2.50	≥205	≥520	≥40	≤200	-	7.98					
		Seawater-corrosion resistance	NSSC 270 (YUS 270)	20Cr-18Ni-6Mo-0.7Cu-0.2N-LC	SUS 312L ASTM S31254	Seawater desalination plant, Seawater heat exchanger, Building exterior material	≤0.020	≤0.80	≤1.00	≤0.030	≤0.015	17.50-19.50	19.00-21.00	6.00-7.00	0.16-0.25	Cu:0.50-1.00	≥300	≥650	≥35	≤230	-	8.03	90	0.46	12.4 (RT)	16.6 (RT-100°C)	196
Oxidation resistance		NSSC 305B (NAR-305B)	19Cr-13Ni-3.5Si	SUS XM15J1 ASTM XM-15	Automotive exhaust system, Burner	≤0.08	3.00-4.00	≤1.00	≤0.030	≤0.030	12.00-15.00	17.50-20.00	-	-	-	≥205	≥540	≥45	≤200	-	7.75	95	0.50	16.3	18.0 (RT-650°C)	196	
JIS	Corrosion resistance	Seawater-corrosion resistance	SUS 329J4L	25Cr-6Ni-3Mo-N-LC	-	Chemical plant, Energy-related plat	≤0.030	≤1.00	≤1.50	≤0.040	≤0.030	5.50-7.50	24.00-26.00	2.50-3.50	0.08-0.30	-	≥450	≥620	≥18	≤320	-	7.80	88	0.46	16.3	10.5	196

### Approved Standards - at Hikari Works -

Examiner	Products	Accreditation		Registration Number
		Quality System	Scope of Accreditation	
TÜV	The austenitic type stainless steel sheet and strip	PED 97/23/EC	Remark: European Pressure Vessels Direction	01 202 J/Q-02 0003/3

# Production Grades

-with information on Characteristics and Applications-  
(Ferritic type and Martensitic type)

Nippon Steel & Sumikin Stainless Steel produces all grades of stainless steel sheet and strip in accordance with JIS 4305 (Cold Rolled Stainless Plates and Sheets) as well as other JIS specifications than #4305 upon customer's request.

Moreover, it can provide with higher grades of stainless steel sheet and strip titled 'NSSC' series which have been developed on the basis of common grades such as JIS in order to meet customers' needs for specific application.

**Ferritic type :** This stainless steel is Cr-type, and 18%-Cr stainless is most typical. It cannot be hardened by heat treatment, while it shows the maximum softness, elongation and corrosion resistance in its annealed state. It offers magnetism as does the martensitic-type stainless steel.

**Martensitic type :** This type of stainless steel can offer heat-treatment effects similar to those of most alloy steels. When subjected to appropriate heat treatment, it can also exhibit wide-ranging mechanical properties. This type features strong magnetism.

Specification group	Characteristics		Symbol of grade (ex-YUS/NAR Series)	Typical composition	Corresponding grade	Applications	Chemical composition by selected element (weight %)										Mechanical properties					Physical properties						
	primary	quasi-primary					C	Si	Mn	P	S	Ni	Cr	Mo	N	Other significant elements	Yield strength 0.2% offset N/mm <sup>2</sup>	Tensile strength N/mm <sup>2</sup>	Elongation %	Hardness Hv	Inside radius of 180° bend test specimen	Density kg/mm <sup>3</sup>	Electric resistivity 10 <sup>-8</sup> Ωm(ρt)	Specific heat kJ/kg°C	Thermal conductivity W/m°C	Coefficient of thermal expansion × 10 <sup>-6</sup> /°C	Young's modulus kN/mm <sup>2</sup>	
JIS products	Weldability		SUS 410L	13Cr-LC	—	Automotive exhaust system, Boiler, Combustion chamber, Burner	≤0.030	≤1.00	≤1.00	≤0.040	≤0.030	—	11.00-13.50	—	—	—	≥195	≥360	≥22	≤200	1.0t	7.75	57	0.46	24.2	11.0	200	
	Ferritic type for general use		SUS 430	17Cr	ASTM 430	Home appliance, Kitchen furnishings for business use, Fractional distillation equipment	≤0.12	≤0.75	≤1.00	≤0.040	≤0.030	—	16.00-18.00	—	—	—	≥205	≥420	≥22	≤200	1.0t	7.70	60	0.46	26.0	10.5	200	
	Corrosion resistance		SUS 444	19Cr-2Mo-Ti,Nb,Zr-LC,N	—	Boiler, Electric boiler	≤0.025	≤1.00	≤1.00	≤0.040	≤0.030	—	17.00-20.00	1.75-2.50	≤0.025	Ti+Nb+Zr : 8(C+N)-0.80	≥245	≥410	≥20	≤230	1.0t	7.75						
NSSC products	Formability	Weldability	NSSC 409L (YUS 409D/NAR-409L)	11Cr-0.2Ti-LC	SUH 409L	Automotive exhaust system, Heat exchanger	≤0.030	≤1.00	≤1.00	≤0.040	≤0.030	—	10.50-11.75	—	≤0.015	Ti:10(C+N)-0.75	≥175	≥360	≥25	≤180	1.0t	7.75		0.46 (0-100°C)	25.1	11.0 (RT-100°C)	200	
		Corrosion resistance, Weldability	NSSC 430D (YUS 430D)	17Cr-0.4Ti-LC,N	SUS 430LX ASTM 439	Kitchen furnishings, Gas burner	≤0.030	≤0.50	≤1.00	≤0.040	≤0.030	—	16.00-18.00	—	—	Ti≥0.10 & Ti≥16(C+N)	≥175	≥360	≥28	≤180	1.0t	7.70	52	0.54 (0-100°C)	28.5 (100°C)	10.6 (RT-100°C)	195	
			NSSC PDX (YUS PDX)	17Cr-0.2Ti-ULC,N	SUS 430LX ASTM 439	Combustion component, Front door of refrigerator	≤0.010	≤0.50	≤1.00	≤0.030	≤0.030	—	16.00-18.00	—	—	Ti:8(C+N)-0.30	≥175	≥360	≥30	≤180	1.0t	7.70				10.2 (RT-100°C)		
			NSSC 432 (YUS 432/NAR-436JIL)	17Cr-0.5Mo-0.2Ti-LC,N	SUS 436J1L	Automotive exhaust system (incl. muffler)	≤0.010	≤0.14	≤0.20	≤0.035	≤0.006	—	17.00-18.00	0.45-0.65	≤0.015	Ti:10(C+N)-0.30	≥205	≥390	≥25	≤170	1.0t	7.70						206
			NSSC 436S (YUS 436S/NAR-436S)	17Cr-1.2Mo-0.2Ti-LSi-LC,N	SUS 436L ASTM 436	Automotive exhaust system, Structural member	≤0.010	≤0.14	≤0.20	≤0.040	≤0.006	—	17.00-18.00	1.00-1.50	≤0.015	Ti:10(C+N)-0.35	≥205	≥390	≥25	≤170	1.0t	7.70		0.46	26.4	10.9	207	
	Corrosion resistance	High toughness	NSSC 180 (YUS 180)	19Cr-0.4Cu-0.4Nb-LC,N	SUS 430J1L	Automotive exhaust system, Automotive trim material	≤0.02	≤1.00	≤1.00	≤0.040	≤0.006	≤0.60	19.00-21.00	—	≤0.025	Cu:0.30-0.60 Nb≥10(C+N)& 0.30-0.80	≥205	≥450	≥22	≤200	1.0t	7.70	59	0.46 (0-100°C)	25.6 (100°C)	11.8 (0-800°C)	208	
			NSSC 220ECO	22Cr-1.1Mo-Nb,Ti-LC,N	SUS 445J1	Hot-water boiler, Roof for housing	≤0.010	≤1.00	≤1.00	≤0.040	≤0.010	—	22.00-23.00	1.00-1.50	≤0.020	Nb+Ti≥16(C+N)	≥295	≥480	≥22	≤200	1.0t	7.69	55	0.49	24.1	11.8	216	
			NSSC 190 (YUS 190)	19Cr-2Mo-Nb,Ti-LC,N	SUS 444	Hot-water boiler, Water tank, Solar-heat collector	≤0.015	≤0.50	≤0.50	≤0.040	≤0.030	—	18.00-20.00	1.75-2.25	≤0.015	Nb+Ti≥16(C+N)	≥205	≥450	≥22	≤200	0.5t	7.75		0.50 (0-200°C)	25.6 (200°C)	11.6 (0-800°C)	215	
			NSSC 190L (YUS 190L)	19Cr-2Mo-Nb-V-LC,N				≤0.015	≤0.50	≤0.50	≤0.040	≤0.030	—	18.00-20.00	1.75-2.25	≤0.015	Nb≥8(C+N) V≤0.20	≥245	≥410	≥22			≤230					
			NSSC 220M (YUS 220M)	22Cr-1.6Mo-Nb,Ti-LC,N	SUS 445J2	Roofing, Siding	≤0.010	≤1.00	≤1.00	≤0.040	≤0.007	≤0.60	22.00-23.00	1.50-2.50	≤0.020	Nb+Ti≥16(C+N)	≥295	≥470	≥22	≤200	1.0t	7.73	68	0.46 (0-100°C)	19.7 (100°C)	10.0	201	
	Weldability	High toughness	NSSC 410W (YUS 410W)	12Cr-LC	SUS 410L	Heat-resistant equipment, Apparatus in less severe environmental conditions	≤0.030	≤1.00	≤1.00	≤0.040	≤0.030	—	11.50-13.50	—	—	—	≥195	≥360	≥22	≤200	1.0t	7.75		0.46	28.7 (500°C)	11.7 (0-650°C)	200	
			NSSC 410WM (YUS 410W-M)	11Cr-Ni-LC,N	SUS 410L	Marine container frame material, High-durability equipment	≤0.030	≤0.50	≤1.00	≤0.035	≤0.025	≤0.50	10.75-12.00	—	≤0.025	—	≥315	≥430	≥20	≤240	1.0t (t≤5)	7.75						
	Heat resistance	High temperature strength	NSSC FHZ (NAR-FH-Z)	13Cr-1Si-Nb-LC	—	Automotive exhaust system, Exhaust gas boiler duct	≤0.020	0.80-1.40	0.20-1.20	≤0.040	≤0.010	—	13.00-15.00	—	≤0.025	Nb:0.40-0.80	≥205	≥410	≥25	≤200	1.0t	7.71				11.4 (RT-500°C)		
			NSSC 450MS (YUS 450-MS)	14Cr-0.5Mo-0.3Nb-0.1Ti	—	Automotive exhaust system (incl. exhaust manifold)	≤0.015	≤2.00	≤2.00	≤0.040	≤0.030	—	13.50-14.50	0.40-1.00	≤0.015	Ti:0.10-0.30 Nb:0.20-0.50	≥205	≥390	≥25	≤200	1.0t	7.72	59	0.46	26.0	12.1	196	
		Oxidation resistance	NSSC 405Si	12Cr-2Si-0.15Al	—	Heater, Barner, Gas burner	≤0.080	1.00-3.00	≤1.00	≤0.040	≤0.030	—	11.50-14.50	—	—	Al:0.10-0.30	≥295	≥490	≥15	≤230	2.0t	7.75	92		18.8 (100°C)	12.0 (RT-600°C)	186	
NSSC HOM (HOM 125)			15Cr-4Al-LC,N	—	Electric-resistant or heat-resistant apparatus	≤0.015	≤1.00	≤1.00	≤0.040	≤0.030	—	14.00-16.00	—	—	Al:3.00-5.00	≥350	≥520	≥15	≤230	—	7.20	125	0.41 (0-100°C)	23.0	11.5	195		
NSSC FH11 (NAR-FH-11)			18Cr-2.5Si-Nb-LC	—	Heater, Barner, Gas burner	≤0.030	2.40-2.80	≤1.00	≤0.040	≤0.030	—	17.50-18.50	—	—	Nb:0.20-0.50	≥205	≥410	≥22	≤230	1.0t	7.70	80		20.9 (100°C)	11.5 (0-650°C)	216		
NSSC 21M	18Cr-2Al-Ti	SUH 21	Muffler for motorcycle	≤0.030	≤1.00	≤1.00	≤0.040	≤0.030	—	17.00-19.00	—	—	Ti:0.10-0.50 Al:1.50-2.50	≥205	≥410	≥15	≤230	—	7.49									
JIS products	Martensitic type for general use	SUS 403	13Cr-LSi-0.1C	ASTM 403	Springs, Metal fittings (such as chains)	≤0.15	≤0.50	≤1.00	≤0.040	≤0.030	—	11.50-13.00	—	—	—	≥205	≥440	≥20	≤210	1.0t	7.75	57	0.46	25.1	9.90	200		
		SUS 410	13Cr	ASTM 410	Machine structural member, Home appliance, Cutlery	≤0.15	≤1.00	≤1.00	≤0.040	≤0.030	—	11.50-13.50	—	—	—	≥205	≥440	≥20	≤210	1.0t	7.75	57	0.46	24.2	11.0	200		
	Formability	Corrosion resistance	SUS 410S	13Cr-0.08C	ASTM 410S	Machine structural member, Home appliance, Cutlery	≤0.08	≤1.00	≤1.00	≤0.040	≤0.030	—	11.50-13.50	—	—	—	≥205	≥410	≥20	≤200	1.0t	7.75	57	0.46	24.2	11.0	200	
		Corrosion resistance	SUS 420J1	13Cr-0.2C	ASTM 420	Turbine blade	0.16-0.25	≤1.00	≤1.00	≤0.040	≤0.030	—	12.00-14.00	—	—	—	≥225	≥520	≥18	≤234	—	7.75	55	0.46	24.2	10.3	200	
	Hardenability	Hardness, Corrosion resistance	SUS 420J2	13Cr-0.3C	ASTM 420	Cutlery, nozzle, bulb, scale	0.26-0.40	≤1.00	≤1.00	≤0.040	≤0.030	—	12.00-14.00	—	—	—	≥225	≥540	≥18	≤247	—	7.75	55	0.46	24.2	10.3	200	

# Guide to Selection of Appropriate Grade of NSSC Series Stainless Steels

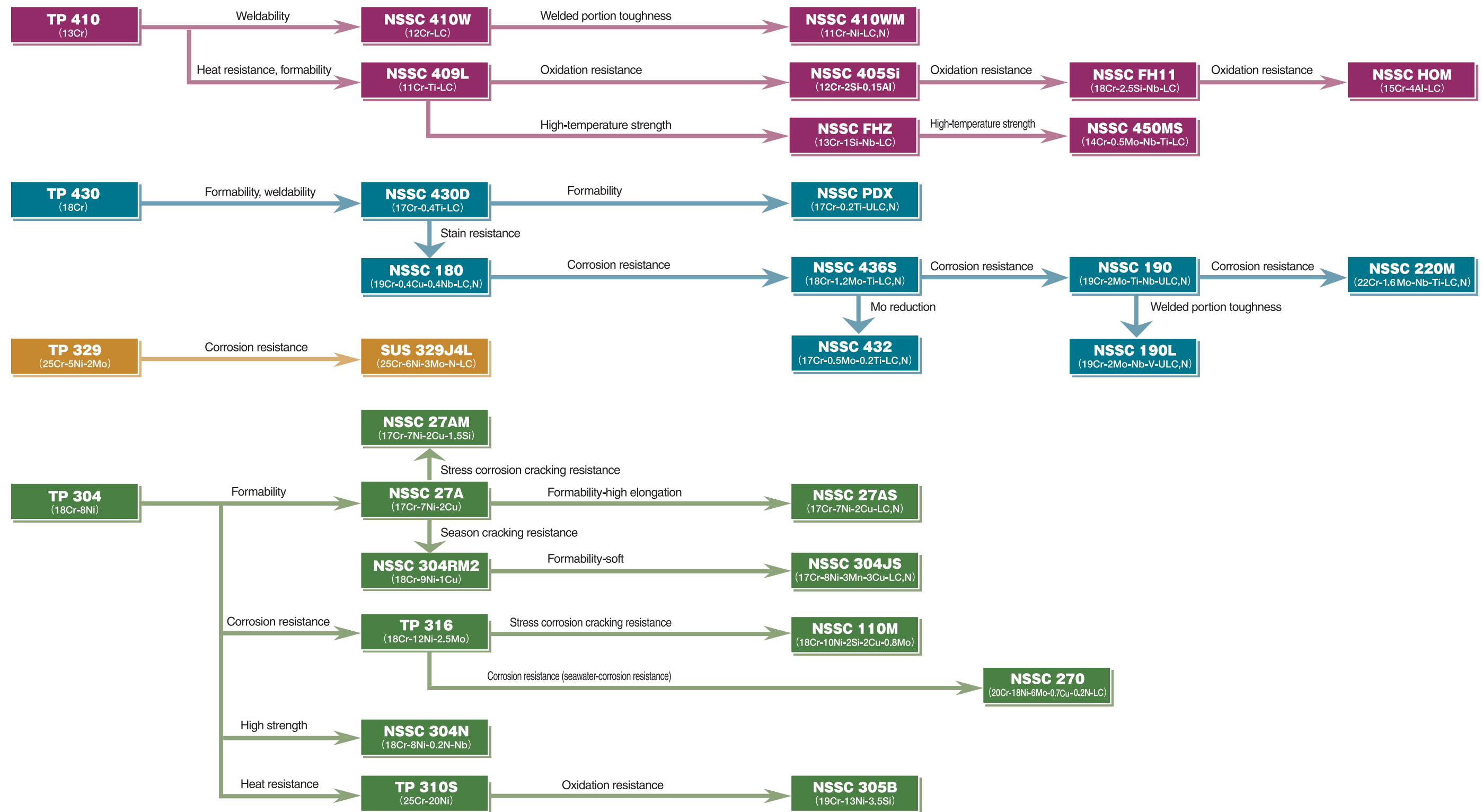



# Sizes Available

Available sizes of Nippon Steel & Sumikinn Stainless Steel's stainless steel sheet and strip for SUS 304 with 2D, 2B and BA finishes are shown below. Thicknesses, widths and lengths other than those listed below can be furnished subject to negotiation. For other steel grades and finishes, please consult us.

## SUS 304 2D and 2B coils

### Thickness, width, available sizes

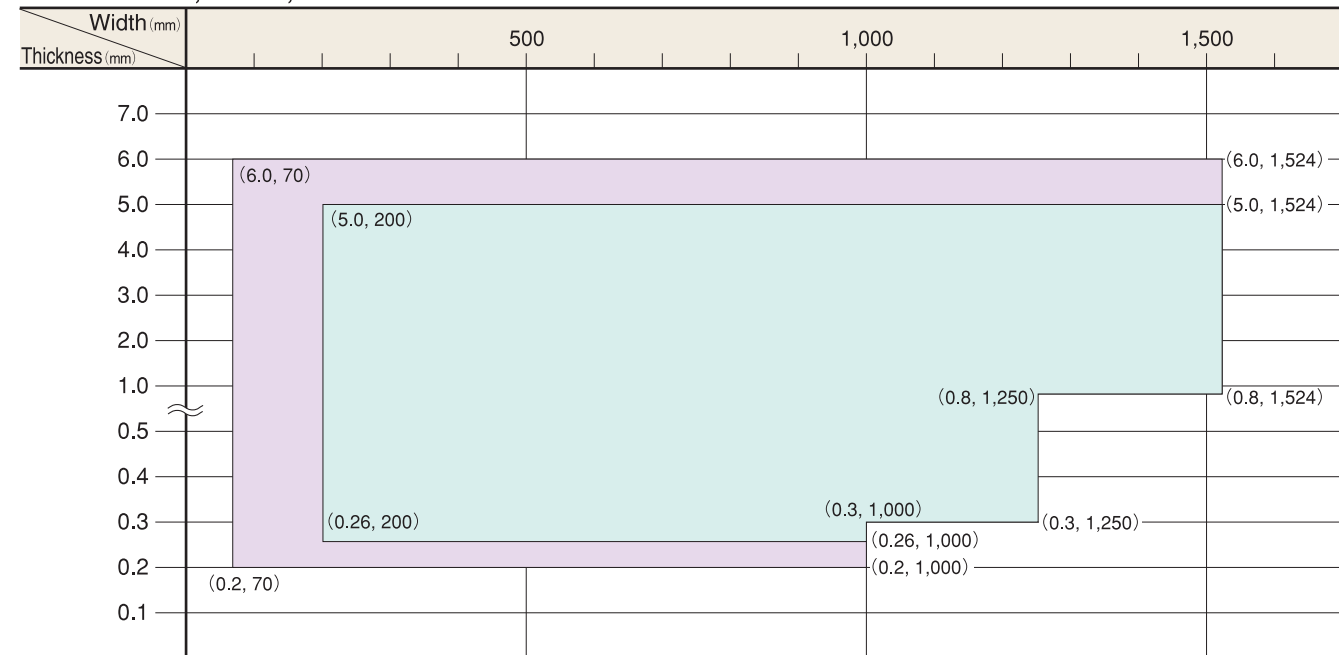

## SUS 304 BA coils

### Thickness, width, available sizes

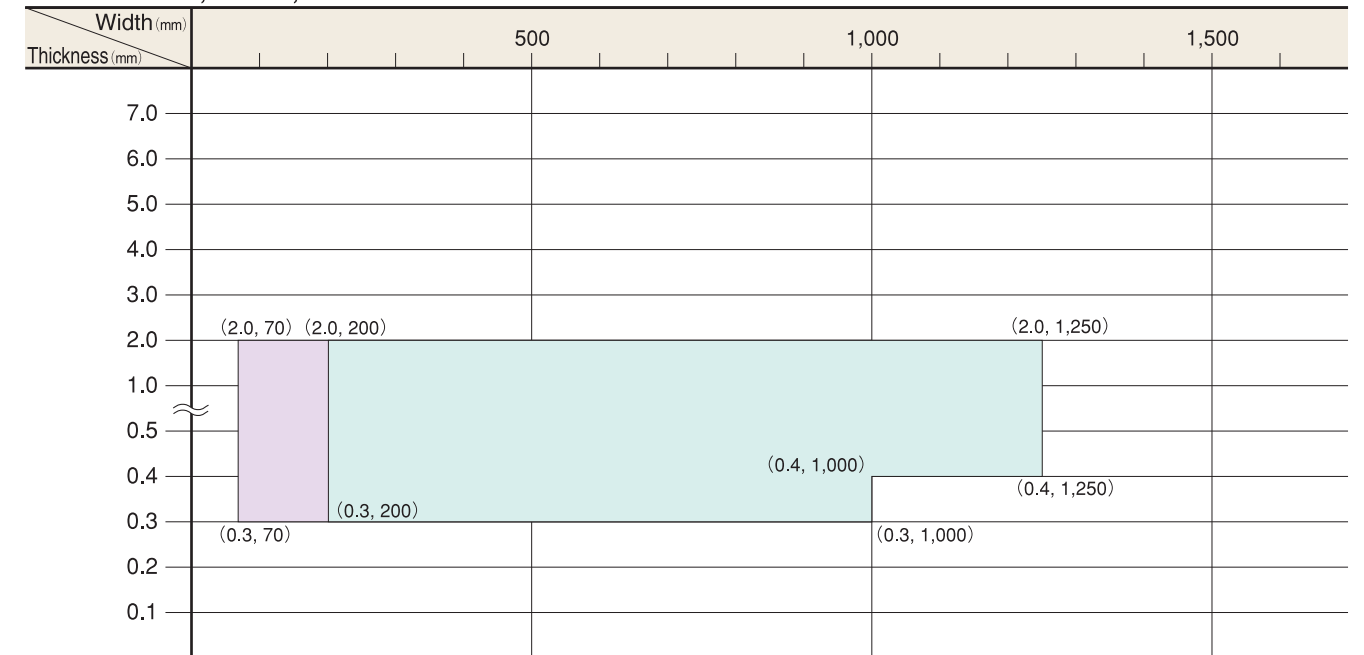

## SUS 304 2D and 2B sheets

### Thickness, width, available sizes

Length: 8,000 mm max.

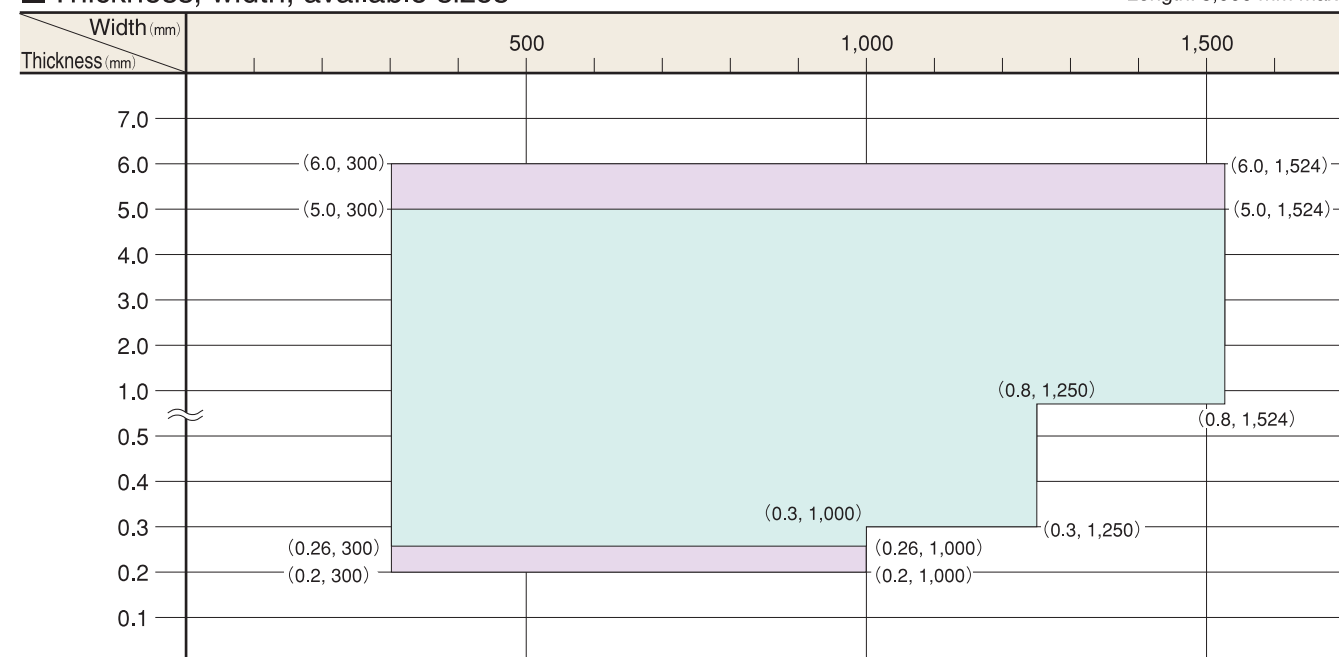

Legend: ■ Sizes available ■ Specifications and delivery available subject to negotiation

## SUS 304 BA sheets

### Thickness, width, available sizes

Length: 8,000 mm max.

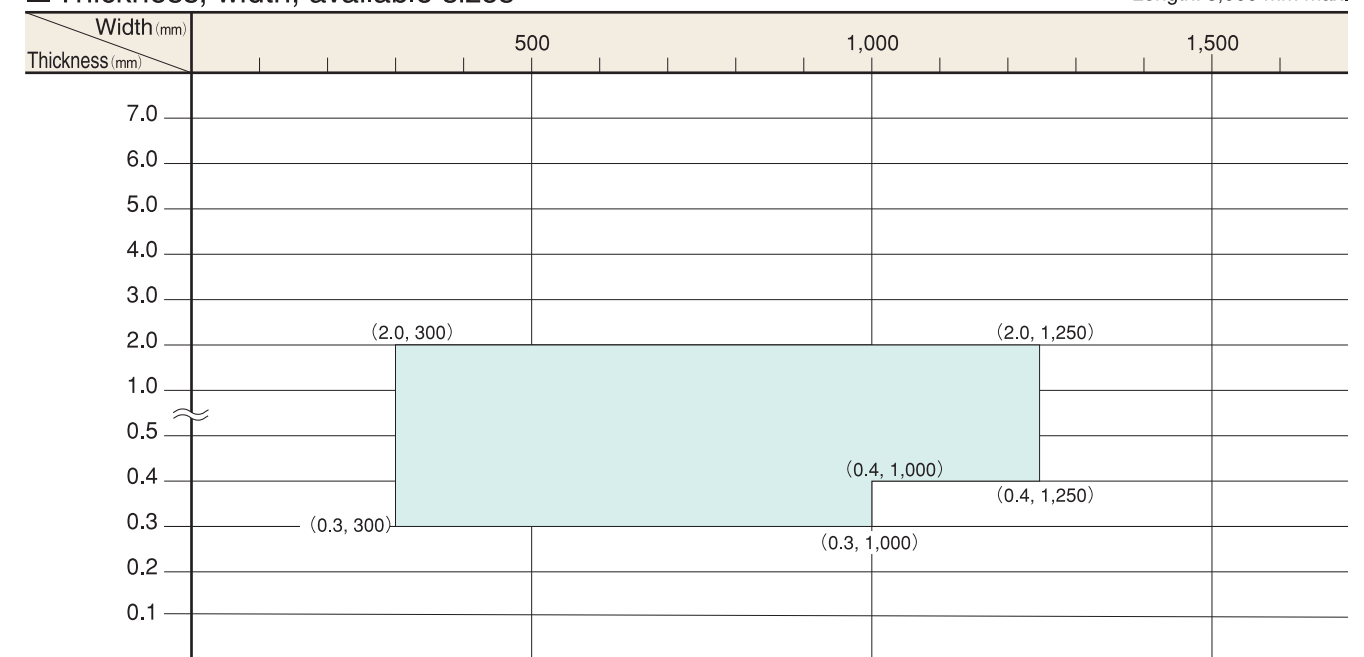

Legend: ■ Sizes available ■ Specifications and delivery available subject to negotiation

# Sizes Available

Available sizes of Nippon Steel & Sumikinn Stainless Steel's stainless steel sheet and strip for SUS 430 with 2D, 2B and BA finishes are shown below. Thicknesses, widths and lengths other than those listed below can be furnished subject to negotiation. For other steel grades and finishes, please consult us.

## SUS 430 2D and 2B coils

### Thickness, width, available sizes

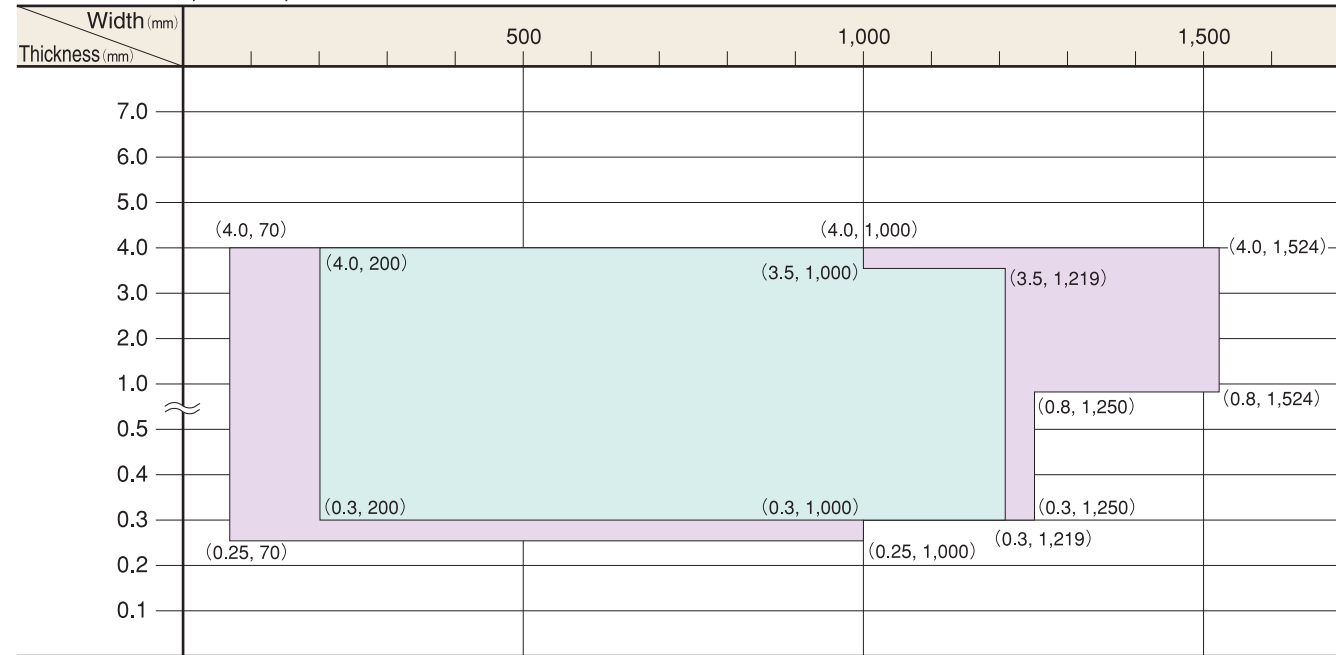

## SUS 430 BA coils

### Thickness, width, available sizes

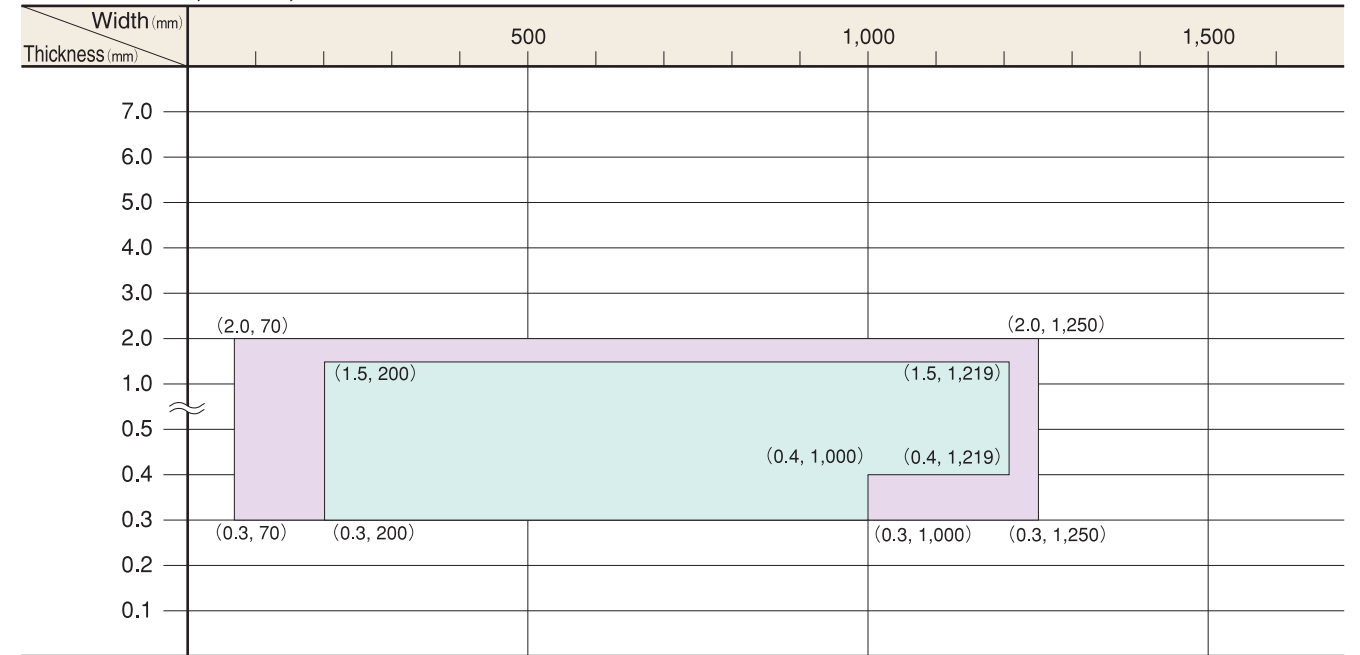

## SUS 430 2D and 2B sheets

### Thickness, width, available sizes

Length: 8,000 mm max.

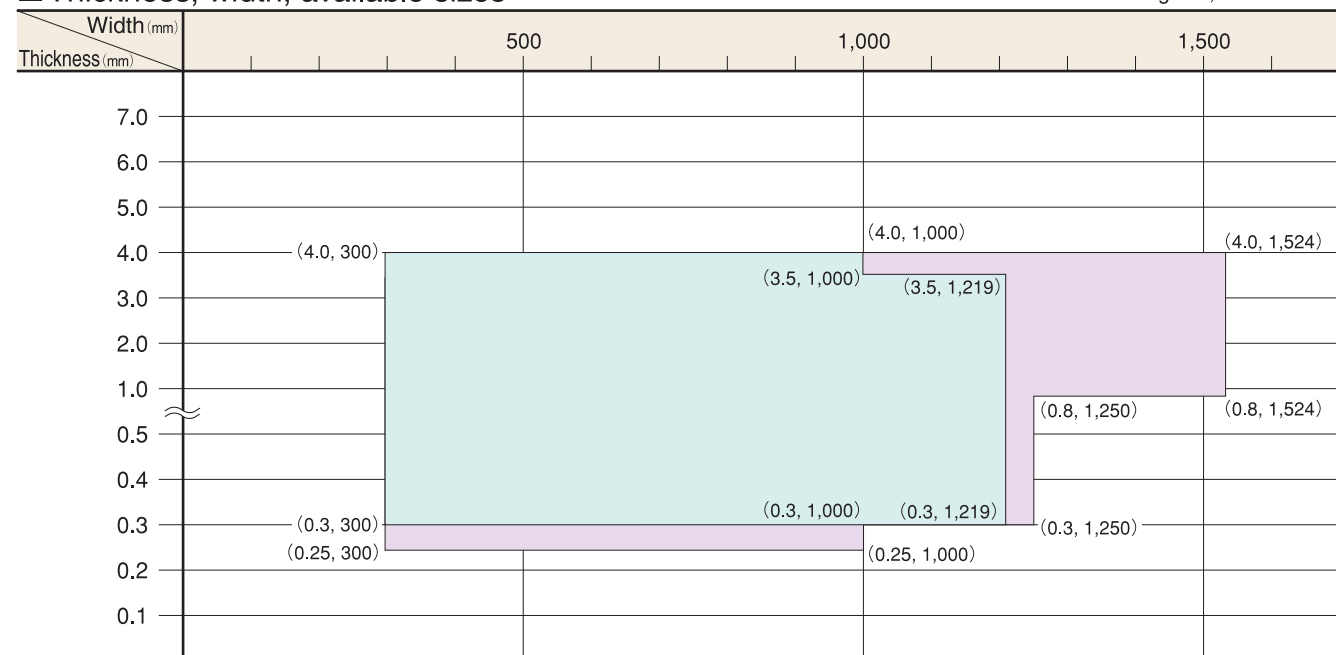

Legend:  Sizes available  Specifications and delivery available subject to negotiation

## SUS 430 BA sheets

### Thickness, width, available sizes

Length: 8,000 mm max.

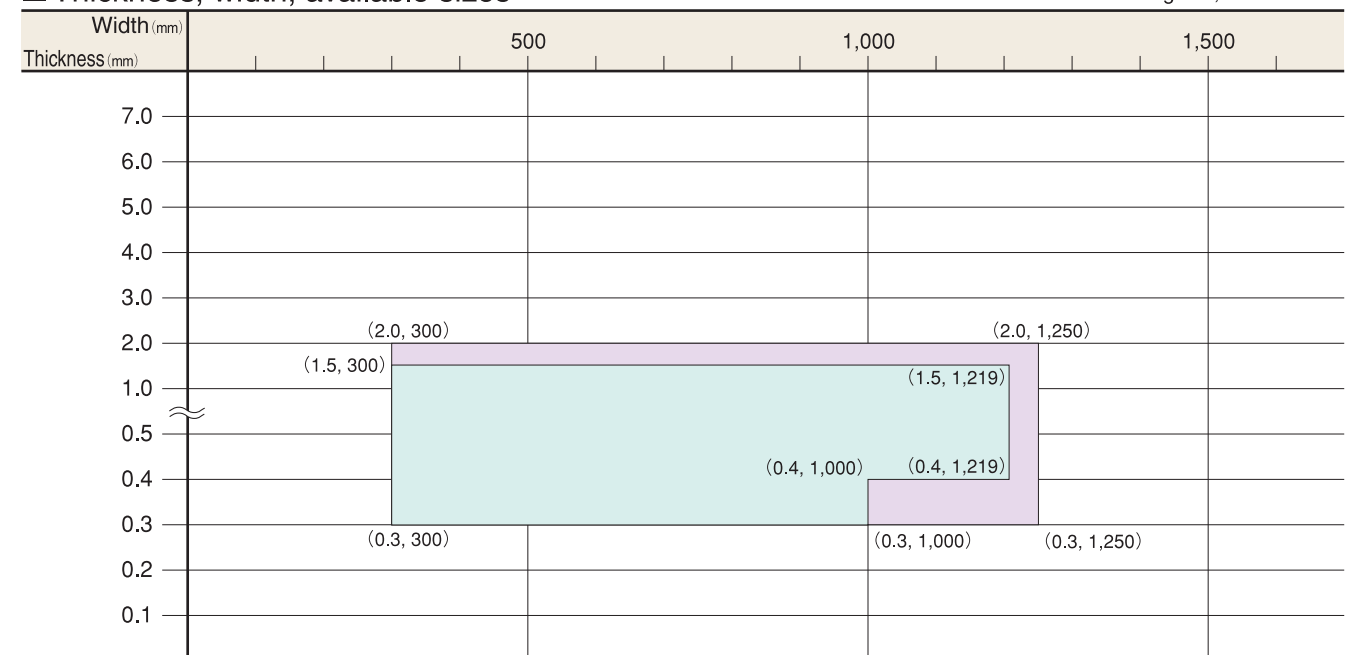

Legend:  Sizes available  Specifications and delivery available subject to negotiation



# Manufacturing Process

Nippon Steel & Sumikin Stainless Steel's stainless steel sheet and strip are produced employing the most advanced facilities, and strict quality control is performed by means of stringent inspection processes.

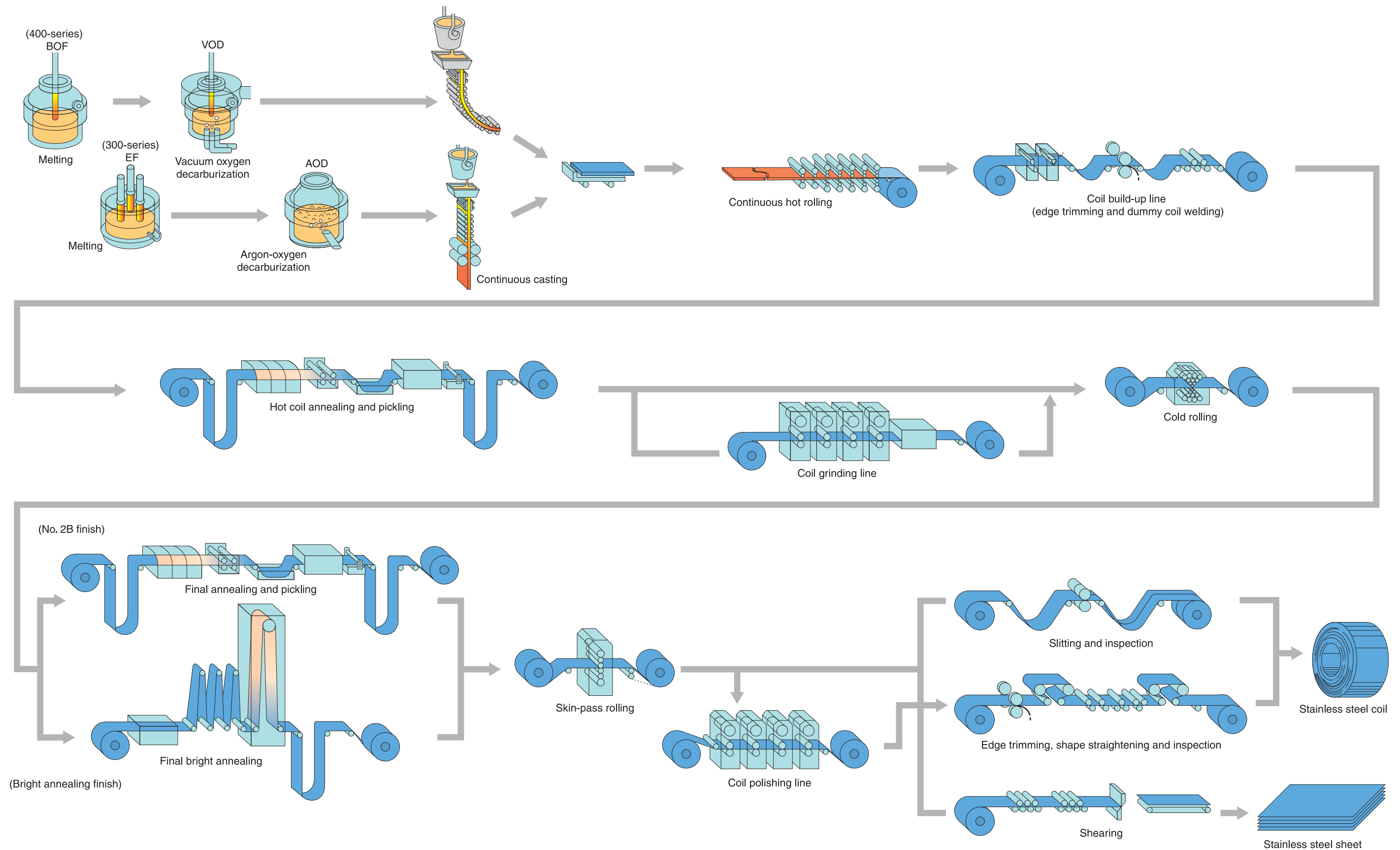

# Surface Finishes

—JIS Products and Nippon Steel & Sumikin Stainless Steel's NSSC Series—

Finishes	Finishing method and degree, and application examples
No. 1	Annealed and descaled after hot rolling. It is suitable for industrial applications requiring heat resistance and corrosion resistance, where smoothness of finish is unimportance, such as chemical tanks, aircraft heaters, steam turbine shrouds and piping.
No. 2D	Annealed and pickled after cold rolling. The finished material is soft and its surface possesses a silver-white luster. The No. 2D finish is suitable for deep drawing and the material after fabrication can be subjected to polishing or buffing because it possesses a dense, cold-rolled surface. It is suitable for such applications as aircraft structural members, roof gutters and heat exchangers.
No. 2B	Bright annealing finish obtained by secondary light processing by means of polishing rolls after No. 2D finishing. It is most suitable for deep drawing that is not so severe. Polishing is much easier than No.2D even after fabrication, and therefore the No. 2B finish is recommended for such applications as medical equipment, milk tanks, cooking appliances, tableware and structural members.
No. 3	Comparatively rough polished finish (100 – 120 mesh). It is recommended for applications in which a semi-polished finish of the surface is required, such as jacket exterior of milk equipment and kitchen counter top.
No. 4	General polished finish, obtained by final polishing agents 150 – 180 mesh after No. 2B finishing. It offers uniform, attractive appearance. Commonly the product of the No. 4 finish is used as it is, but further high-grade finish can be added to this finish if required. Because the finish is clean and sanitary, it is suitable for milk and food processing equipment and medical equipment.
Buffing polished	It offers high reflectivity. The finely ground surface is finished further by buffing, but the abrasion lines remain. It is suitable mainly for structural and decorative applications.
HL (Hair-line)	Finish to which continuous abrasion lines are added to No. 4 finish. Repair after welding is easy and accordingly it is suitable for structural and similar applications.
BA (Bright annealed)	Very attractive finish by means of heat treatment in an inert atmosphere furnace and further of light cold processing using polishing rolls after cold rolling. Due to its attractive finish, the BA finish is suitable for various decorative items and applications requiring unimpaired surface attractiveness after light fabrication. For pressed and formed products, simple buff-polishing can provide them with luster.
PB	Finished with polished unique patterns by using special rolls. It is suitable for such applications as structural members, medical equipment and home appliances.
DF	Finished with refined uneven surfaces by using special rolls. It is suitable for applications where mat finish is required to prevent glare and for decorativeness of finished products.
Embossed	Finished with unique patterns embossed using special rolls. It is suitable for applications as building materials, kitchen fixtures and general household implements.

# Table of Mass

The table below shows the mass of the products having the standard size of 1,000 mm width × 2,000 mm length.

(kg)				
Thickness (mm)	SUS 430	SUS 304	SUS 316	SUS 410
0.2	3.08	3.17	3.19	3.10
0.3	4.62	4.76	4.79	4.65
0.4	6.16	6.34	6.38	6.20
0.5	7.70	7.93	7.98	7.75
0.6	9.24	9.52	9.58	9.30
0.7	10.8	11.1	11.2	10.8
0.8	12.3	12.7	12.8	12.4
0.9	13.9	14.3	14.4	14.0
1.0	15.4	15.9	16.0	15.5
1.2	18.5	19.0	19.2	18.6
1.5	23.1	23.8	23.9	23.2
2.0	30.8	31.7	31.9	31.0
2.3	35.4	36.5	36.7	35.6
2.5	38.5	39.6	39.9	38.8
3.0	46.2	47.6	47.9	46.5
3.2	49.3	50.8	51.1	49.6
4.0	61.6	63.4	63.8	62.0
5.0	77.0	79.3	79.8	77.5
6.0	92.4	95.2	95.8	93.0
Specific gravity (kg/mm/m <sup>2</sup> )	7.70	7.93	7.98	7.75



# Marking and Packing

## ● Example of marking

### ■ Steel sheet

COLD ROLLED STAINLESS STEEL SHEETS		SHEETS 106	
SPEC: SUS304			
SIZE	0.8 X 4' X 8'	FINISH: BA	
N.M (ACT)	1,971KG	G.M (ACT)	2,120KG
INSPECTION NO.	31-A3874	CASE NO.	0000001
		CAST NO.	E32880
NIPPON STEEL & SUMIKIN STAINLESS STEEL CORPORATION			HIKARI WORKS MADE IN JAPAN G2

### ■ Steel coil

COLD ROLLED STAINLESS STEEL SHEET IN COIL			
SPECIFICATION		FINISH	
SUS304		NO. 2B	
SIZE	0.5 X 1000.0 X C		
NET MASS (ACT)	4,321KG	GROSS MASS (ACT)	4,362KG
		COILS	1
INSPECTION NO.	31-40139	CASE NO.	0000001
		CAST NO.	E32764
NIPPON STEEL & SUMIKIN STAINLESS STEEL CORPORATION			HIKARI WORKS MADE IN JAPAN

## ● Example of packing

### ■ Steel sheet

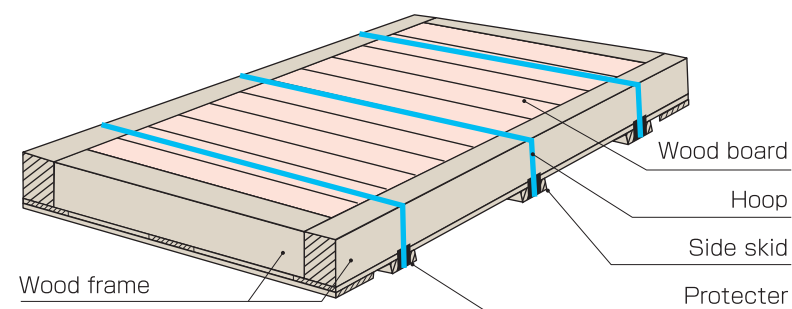

### ■ Steel coil

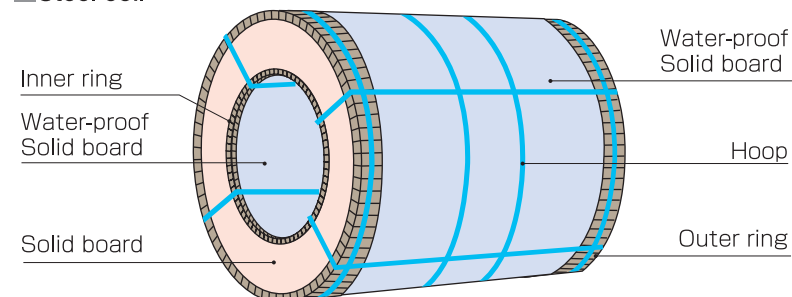

# Product Handling Instructions

If stainless steel sheets are improperly handled or used, they cannot fully exhibit their characteristic features. When handling or using stainless steel sheets, attention should be paid to the following points.

## ● Storage and Unloading

1. If stainless steel sheets get wet during unloading or storage, rusting will occur. Accordingly, stringent care should be taken to avoid their unloading on rainy days or their getting wet by seawater. Storage at high humidity or in a sulfur-dioxide atmosphere should be avoided. Storage in a dry, clean place is recommended.
2. Damaged packing paper should be repaired.

### ⚠ Warning

- The falling and rolling of coils or the collapse of piled sheets are extremely dangerous. To prevent accidents, attention must be paid to their secure storage.

## ● Handling

1. To avoid injury, do not handle unpacked sheets by bare hand. In handling these sheets, careful handling and use of protective gloves are recommended.

### ⚠ Warning

- When the coil binding hoops are removed, the removal should be performed with the coil end located directly under the coil center to avoid sudden spring-out, or these operations must be done in a place where safety can be assured and no danger is posed if the coil end springs out upon release.
- The coil is formed by winding flat strip under tension. When the binding hoops are removed, this tension is released and the coil end will spring out endangering workers or causing damage. Careful attention must be paid to coil handling operations.

# Information Required with Orders

Stainless steel sheet and strip can demonstrate their optimum characteristic performances when the appropriate steel grade is properly selected in terms of application, design, fabrication and other similar conditions. Please place your orders after obtaining the advice of Nippon Steel & Sumikin Stainless Steel regarding the above conditions.

## ● When placing orders

Please include the following information as specifically as possible.

1. Specification and steel grade, finish, thickness, width, length, quantity and the like of stainless steel sheet or strip
2. End use and fabrication conditions, application, application conditions, welding and bending conditions, and the like
3. Delivery term.

## ● Technical services

Please feel free to consult Nippon Steel & Sumikin Stainless Steel's headquarters or its sales offices as to technical matters such as grade selection and applications of stainless steel sheet and strip. Nippon Steel & Sumikin Stainless Steel is ready to offer appropriate technical services on the basis of extensive research and expertise and achievements accumulated over long years of technical services.